

DX20

Digital Mixer

USER MANUAL

PANEL

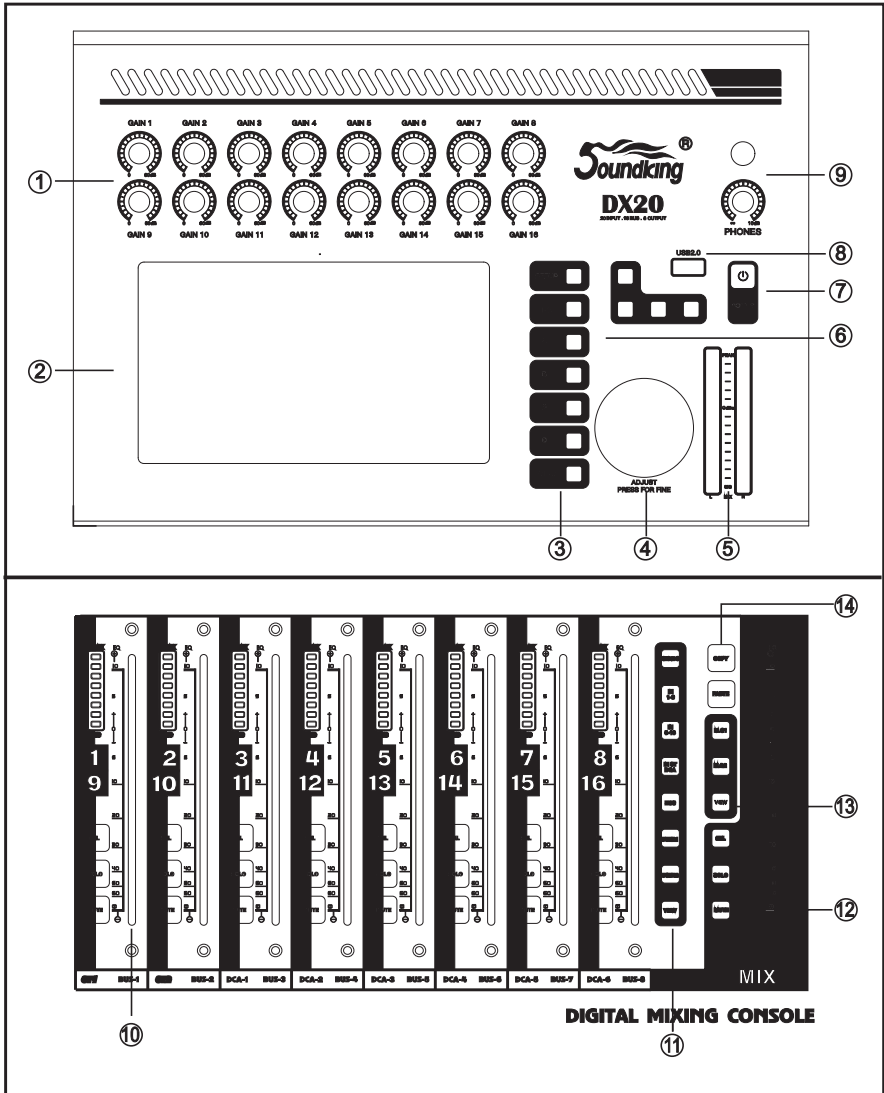

1. Gain knob: Adjusts the gain of the corresponding input channel in the range 0-60dB.
2. Screen: Edit and control the mixer via the touch screen.
3. Function key
 - Setup system function
 - FX effect
 - A, B, C, D self-defined function
 - VIEW
4. Adjust parameter knob: Operates with a touch screen to adjust parameters.
5. 16 level meter: display main output level.
6. Play key: Control MP3 playback, pause, previous, next and recording.
7. Power supply button.
8. USB2. 0: You can insert a U-disk to play songs, import and export scenes, etc.
9. Headphone: Headphone output connector and volume control knob.
10. Channel fader: with SEL, SOLO, MUTE, 8 level meter and motorized fader.
11. Layer control key
 - SENDS fast send
 - IN1-8 channel 1 to 8
 - IN9 16 channel 9 to 16
 - IN ST DCA stereo input and DCA group
 - BUS bus channel
 - USER1, USER2 user-defined
12. Master channel fader: with SEL, SOLO, MUTE and motorized fader.
13. Mute group key.
14. Copy and paste button: Copy between channels, quickly copy the parameters of one channel to another.

REAR PANEL

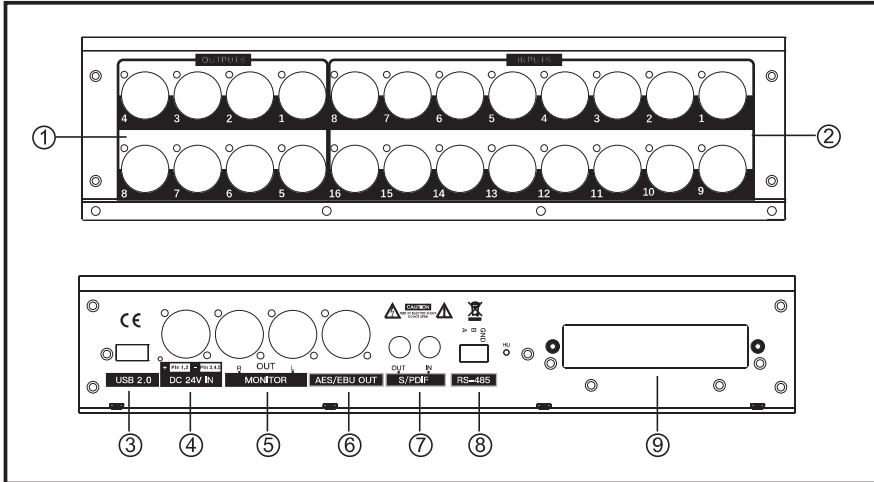

1. Outputs 1-8: 8 XLR output interface for analog signals to external devices via XLR connection cables. Outputs 7-8 output the master channel signal by default.
2. Input 1-16: 16 input interface for connecting a line or microphone to an audio signal source.
3. USB2.0: same function as front panel USB interface.
4. Power supply: input 24V DC power supply interface.
5. Monitor: output stereo monitor signal.
6. AES/EBU: AES/EBU digital signal output via XLR cable.
7. S/PDIF: S/PDIF digital input and output.
8. RS-485: External control of the mixer via RS-485 protocol.
9. Expansion slot: Multi-track recording card interface.

Input Channel

DX20 has 12-channel mono inputs, 2 analogue stereo inputs, 1 stereo S/PDIF input channel and 1 stereo USB input. INPUT 1-8 and INPUT 9-12 ST-USB buttons are for input page up/page down. INPUT 1-8 covers 8 channels MONO input channel CH1~CH8, INPUT 9-12 ST-USB covers 4 mono inputs (CH9~CH12), 2 analogue stereo input channels, 1 stereo S/PDIF input and 1 stereo USB input. Press INPUT1-8 and INPUT9-12 ST-USB page button, or slide left/right to flip pages.

MIC Channel

MIC input channels possess five individual modules, which are Input Stage, EQ, Dynamics, Bus Send and Output Stage. With single press any module, the sub-page will pop up and you could shut it down if you press the “close” button.



① Input Stage

This module indicates settings of 48V phantom power, phase, delay, HPF and effects insert on the channel

② EQ

This module indicates EQ curves on the channel

③ Dynamics

This module indicates Dynamics curves on the channel

④ Bus Send

This module indicates status of sending inputs to Busses, including the bus being sent and its level and Pan value.

⑤ Output Stage

This module displays Mic input channel's name, Pan value, Solo, Mute, fader level setting and level meter information. Single press **CH1**, channel name and color can be edited, and you could specify the channel name and color with the soft keyboard popped up at the same time.

Input Stage subpage



① 48V phantom power

Press the key, to enable the 48V phantom power. Press again to disable it. The default is set as disabled.

② Switch channels

Press the key, to choose previous or next channel within a same layer

③ REV

Press the key to enable reverse. Press again to disable it. The default is set as disabled.

④ Delay

Press to enable the delay, and the default is set as disabled. To adjust the time of delay by turning the main Encoder on the control panel or on the touch screen (fine tuning can be activated when pressed the knob down). The delay ranges from 0ms to 200ms, while the default is 0ms.

⑤ HPF

Press to enable the HPF, and the default is set as disabled. To adjust the frequency of HPF by turning the main Encoder on the control panel or on the touch screen (fine tuning can be activated when pressed the knob down). The frequency ranges from 16 Hz to 400 Hz, while the default is 16 Hz.

⑥ Insert

Press the key of any effect module, to insert this module before the EQ on the channel. All effects cannot be used on more than one channel, and all inputs can only be inserted with one effect module (the link parameter of this module is the serial number of the channel). The busses (Bus1~Bus8, L&R) can be inserted with two effect modules at the same time, which is sequenced to insert into the bus by the priority of selection. When the selected module is occupied by other channel or bus, you will see a window popped up and say: "The module can be used only once and it is already used by . Are you sure you want to use the module forcibly now "Yes No". Access path of effect setting: SETUP→FX→double press to select the module

⑦ Trim

Click the button to open it, which is closed by default. Adjust through the touch knob or the knob on the panel (normal rotation of the knob is coarse adjustment, press and rotate to fine adjustment). The range is -20 to 20dB, with a default value of 0dB.

EQ Sub Page

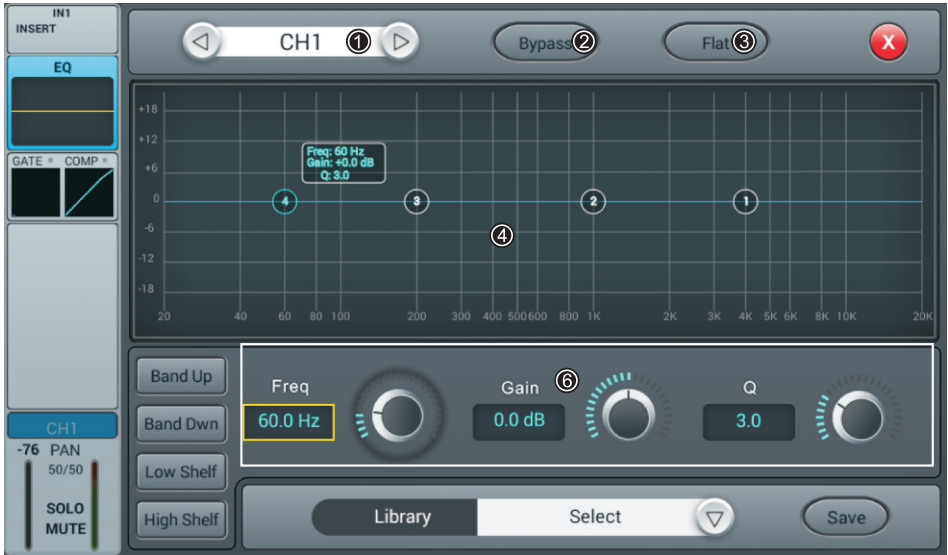

① Switch Channels

Single press the key to switch between previous or next channel on the same layer

② Bypass

Single press the key to enable Bypass, i.e. bypassed the EQ, press again to bring the EQ back. The default is set as disabled.

③ Flat

Single press the key to flat the curves in EQ graph. The default is set as disabled.

④ 4-band EQ graph

There are four points on the curve stand for the key frequencies (each ranges from 20Hz to 20KHz) of four bands EQ filters, which you could drag, in order to set parameters of 4-band EQ filters. There is a floating frame shows the parameter (gain, key frequency and Q value) of this filter when you selected a certain point on the curve.

⑤ Select Key of 4-band EQ filter

Single press the key of a certain frequency range, to select the filter for it.

⑥ Parameter Settings

To adjust Gain, Frequency or Q value with the touch knob or the knob on the control panel (general tuning by normally turning the main Encoder, press down the knob to access to the fine tuning)

Gain: to allow 18dB reduction or increase within the selected frequency range, default as 0dB.

Frequency: Band up/Band Dwn can switch between 4 frequencies; Low shelf/High Shelf can switch 1 and 4 to Shelf mode.

Q: adjust the bandwidth of 4-band filters in the EQ, ranges from 0.5(wide) to 10.0(narrow), default as 0.5.

⑦ Library

Save or load user's EQ settings. Single press the dropdown button and select a library file from a popped-up list, in order to load the EQ setting. Single press the "Save" button after you have done with EQ settings, then select the library file (there are 16 names of library, Preset 1~Preset16) from the popped-up list. You could simply edit the name of library with a popped-up keyboard and press "confirm" or "cancel" to save it or not.

Dynamics sub-page

The sub-page includes channel selection, library, Gate, Compressor, Side Chain, etc.



① Switch Channels

Single press the key to switch between previous or next channel on the same layer.

② Side chain

press dropdown button, and select Side chain channel (CH1~CH12) in the list (CH1~CH12 ST1 ST2) . Side Chain can select Pre/Post Eq of other single channel.

③ Gate

IN: Single press the key to enable Gate, press again to disable it. The default is set as disabled.

Gate curve: Y-axis indicates the Threshold, X-axis indicates time factor. Up curve is determined by Attack, horizontal curve is determined by Hold, down curve is determined by Release.

Parameter Adjustment: To adjust the parameter of Gate by dragging the slider, or turning the main Encoder on the control panel (fine tuning can be activated when pressed the knob down). Double press the parameter frame to set it as default.

Threshold: Adjust the threshold of noise gate on the channel, ranges from -80 dB to 0 dB with default @ -80dB. Any signal lower than Threshold will be cut off, as a result, the level of the signal has to surpass the threshold in order to get through the noise gate.

Hold (time of hold): from 2 ms up to 2000 ms with default @ 2 ms.

Attack (time of start): from 0.5 ms to 100 ms with default @ 3 ms.

Release (time of release): from 2 ms to 2 s with default @350 ms (compatible with many kinds of sound source).

Depth: adjust attenuation of signals lower than the Threshold, ranges from 0 dB to -80 dB with default @-80 dB.

④ **Compressor**

IN: Press the key to enable Compressor, press again to disable it. The default is set as disabled.

Compressor: Threshold modifies breakpoint's position on the curve, Ratio modifies the bending rate of the curve above the breakpoint, Gain controls the vertical position of the diagonal.

Parameter Adjustment: To adjust the parameter of Gate by dragging the slider, or turning the main Encoder on the control panel (fine tuning can be activated when pressed the knob down).

Threshold: Adjust the Threshold of the compressor on the channel ranges from -80 dB to 0 dB with default @ -20 dB. Any signal lower than Threshold will not be compressed. To decrease the level of the signal higher than Threshold to a certain extent.

Ratio: Adjust compression ratio, from 1.0 to 20.0 with default @1.0.

Attack: from 0.5 ms to 100 ms with default @25 ms.

Release: from 20 ms to 5 s with default @350 ms (compatible with many kinds of sound source)

Gain: To compensate the compression, from -12 dB to +12 dB with default @0 dB.

⑤ **Library**

save or load the user Dynamics setting. Single press the button to display the library list to select one document. It loads the Dynamics setting. After setting the Dynamics parameters, single press Save button to display library list (16 library names, Preset 1~Preset 16 and select one document. This document is in the status of being edited. Change the library name via the displayed keyboard, then click Confirm to confirm the saving. If you do not want to change the library name, click Cancel.

⑥ **Bypass**

Single press the key to enable Bypass, to bypass Dynamics (Gate & Compressor), press again to disable Bypass meanwhile enable Dynamics. The default is set as disabled.

Bus Send Sub-page

The input channel can send signal into 4-channel mono bus, 4-channel stereo bus and L/R master output bus.



① Channel Switch

Single press the key to switch between previous or next channel on the same layer.

② Bus-send enable

Single press a bus button, to send signal to this bus, press again to disable the send.

③ PreFader/PostFader Switch

The default is set as PreFader, single press the key to switch to PostFader, press again to set it back to default.

④ PAN control

he default is set as 50|50, the PAN value can be tuned by dragging the slider, or turning the main Encoder on the control pane. Double press the parameter frame to set it back to default.

⑤ Send level control

Control the level of signal by drag the slider up and down.

Output Stage Sub-page

The sub-page mainly contains PAN, Solo, Mute, fader control and signal level display.



① Switch Channel

Single press the key to switch between previous or next channel on the same layer.

② PAN control

The default is set as 50|50, the PAN value can be tuned by touch knob, or physical knob on the control panel.

Double press the parameter frame to set it back to default.

③ Link

Single channel can be used as stereo channel.

④ Solo

Single press the key to enable monitor, press again to disable it. The default is set as disabled.

⑤ Mute

Single press the key to enable mute, press again to disable it. The default is set as disabled.

⑥ Fader control

Control the volume of fader level by dragging the slider, or faders on the control panel, the parameter frame real-timely displays the value of fader level. Double press the parameter frame to fast set it back to 0.

⑦ Meter level display

The level meter of channel signal, indicating post-fader signal level of the channel.

Stereo channel and DCA



The ST1 and ST2 input channels are the same as the Mono channel, and also include four modules: Input Stage, EQ, Bus Send and Output Stage. Click a module to pop up the corresponding sub page; Click the Close button on the sub page to exit the sub page.

DCA part

On the DCA page, there are six groups, which can be controlled as needed. By default, no group is added

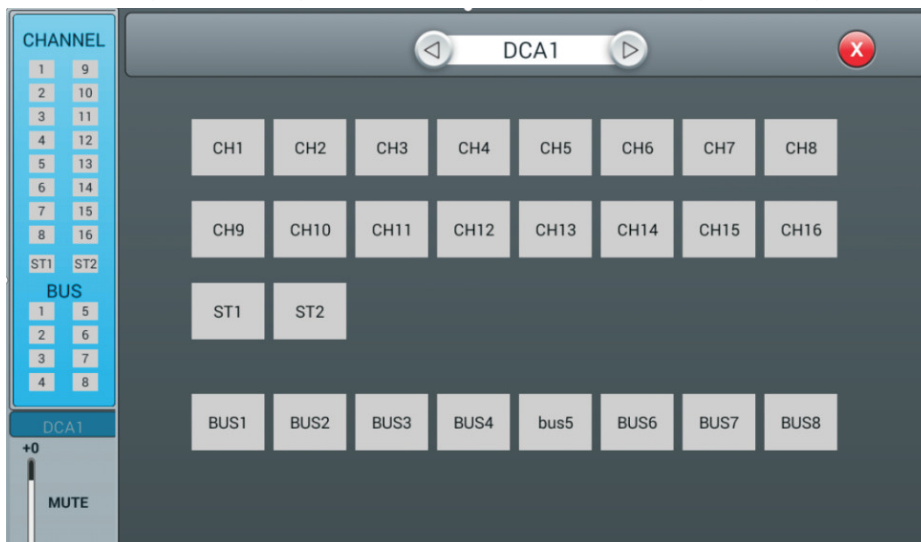

Double click to enter CHANNEL, the DAC option enters the grouping configuration page.

Switchable DCA channel

You can freely select the channel to be added



Double click to enter DCA, Fader page

Switchable DCA channel

Can control whether the selected channel is muted

Fader can control the transmission volume of the selected channel

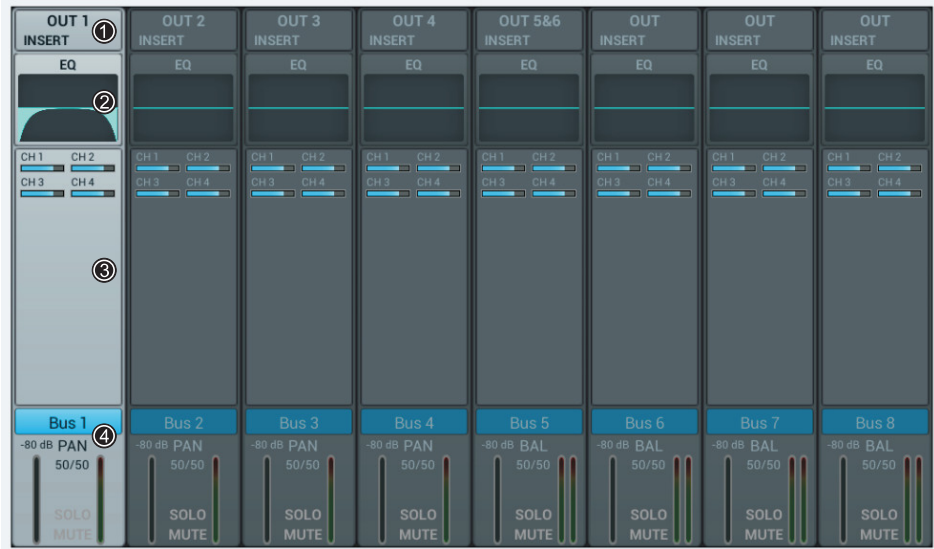

① Input Stage

The module shows the setup of output and effect insert which are assigned from the bus.

② EQ

The module shows the EQ curve of the bus.

③ Input Source

The module shows the channel info sent to the bus

④ Output Stage

The module shows the name of the bus, Pan/BAL value, Solo, Mute, delay setup, fader level and meter
By double pressing Bus 1 the name of the channel can be edited through the soft-keyboard popping up.

Mono Bus Bus 1 ~Bus 4 are Mono busses.

Input Stage Subpage

The page contains Send and Insert. Bus1~Bus4 can send signal to Bus5~Bus8 and L/R master output, Bus5~Bus8 can only send signal to L/R master output.

OUT3 indicates physical output 3 assigned to the bus, and it shows OUT if there is no bus assigned to the physical output. Please refer to the page of Patch for operation of assigning busses to physical outputs.



① Switch Channel

Single press the button to switch between previous or next channel on the same layer

② Bus send enable

Single press a bus button, to send channel signal to the bus, press again to disable.

③ PreFader/PostFader toggle selection

The default is PreFader. Single press the button, to toggle PostFader, press again to set it back to default.

④ PAN control

The default is 50|50, the PAN value can be tuned by dragging the slider, or turning the main Encoder on the control panel. Double press the parameter frame to set it back to default.

⑤ Send level control

Control the level of signal by drag the slider up and down.

⑥ Insert

Press the button of any effect module to insert this module before the EQ on the channel. All effect module cannot be shared on more than one channel. The busses (Bus1~Bus8, L&R) can be inserted with two effect modules at the same time, which is sequenced to insert into the bus by the priority of selection. When the selected module is occupied by other channel or bus, you will see a window popped up and say: " The module can be used only once and it is already used by **. Are you sure you want to use the module forcibly now " Yes or No "

EQ Subpage

This Subpage is the same as EQ Subpage of the MIC channel, please refer to MIC channel EQ page.

Output Stage Subpage

The page contains Delay, PAN, Solo, Mute, fader level control and signal level display. (the output of Bus5~Bus8 and L&R bus is similar with Bus1~Bus4).



① Switch Channel:

Single press the key to switch between previous or next bus channel on the same layer.

② Delay:

Press **IN** to enable the delay; the default is disabled. Adjust the delay time by turning the main Encoder or on the touch screen (fine tuning can be activated by pressing the main Encoder knob). The delay ranges from 0ms to 200ms, while the default is 0ms.

③ PAN control:

The default is 50|50, the PAN value can be tuned by dragging the slider, or turning the main Encoder on the control panel. Double press the parameter frame to set it back to default.

④ Solo:

Single press the button to enable monitor, press again to disable it. The default is disabled.

⑤ Mute:

Single press the button to enable mute, press again to disable it. The default is disabled.

⑥ Fader control:

Control the volume of fader level by dragging the slider, or faders on the control panel, the parameter frame real-timely displays the value of fader level. Double press the parameter frame to fast set it back to 0.

⑦ Meter level display:

The level meter of channel signal, indicating post-fader signal level of the channel.

Setup page

The page contains Information, Sample Rate, Delay Unit, System, WiFi, Remote, Brightness and Time & Date.

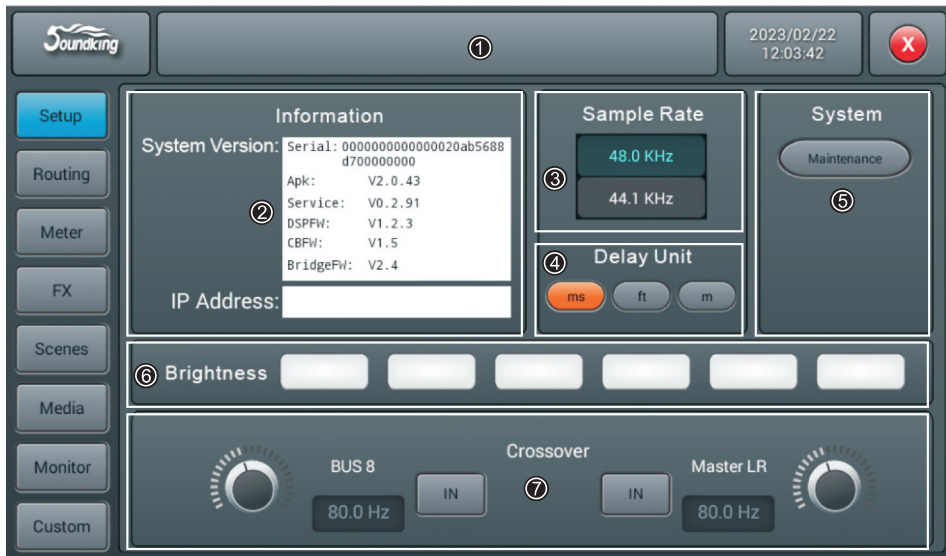

① Scenes

Shows the name of scenes.

② Information

System Version shows the version of APK, DSP, Fader and other softwares on this console. IP Address shows the IP address of the console.

③ Sample Rate

The default setting is 48.0 KHz. When single press 44.1 KHz, a window pops up " The Sample Rate of 44.1 KHz is only used for Digital Outputs.", then the 44.1 KHz light on, and the 48 KHz light off. The default is always 48.0 KHz after rebooting the system

④ Delay Unit

Single press any one among three " ms ", " ft " and " m " buttons, to choose the unit of delay time. The default is " ms ". After rebooting the system, the unit of delay time is always what you set before you had powered off the console last time.

⑤ System

Contains Maintenance and Home Screener two options, please refer to the page of Maintenance Subpage for details.

⑥ Brightness,

Adjust the brightness of the touch screen.

Six units to indicate the level of brightness, the default is three units. After rebooting the system, the unit of brightness is always what you set before you had powered off the console last time.

⑦ Crossover setting

Single press SUB8 **IN**, the crossover works. At this time, BUS8 works in bass mode, the frequency adjustment knob can change the crossover frequency. Filter slope is 24dB/oct. The crossover frequency adjustment range is 40Hz-300Hz. Single press Master L/R **IN** button, crossover works. At this time, Master L/R works in the full range low cut mode. the frequency adjustment knob can change the crossover Frequency. Filter slope is 24dB/oct. The crossover frequency adjustment range is 40Hz-300Hz. Using these two crossovers reasonably can form 2.1 channel reinforcement mode.

Routing Page

Routing page local subpage

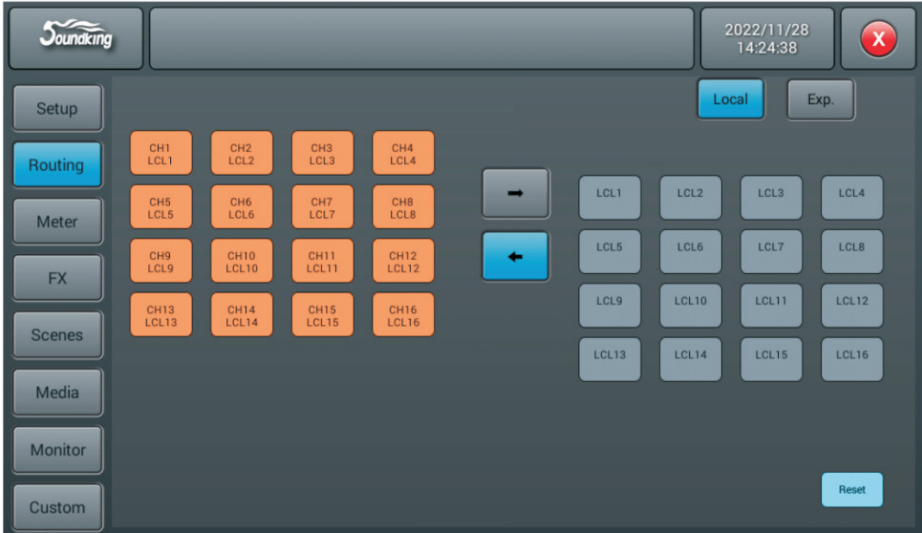

Local input routing, input signals can be allocated to any single or multiple input channels

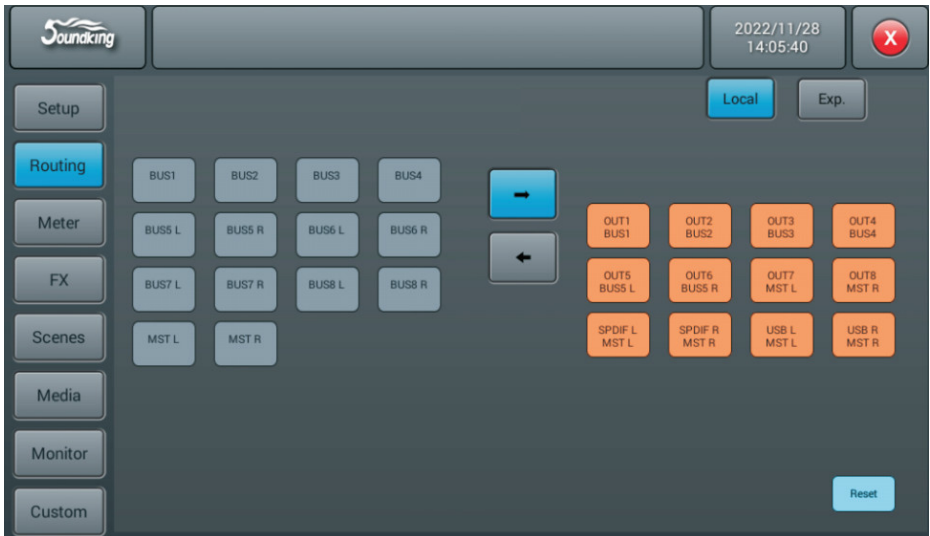

Local output routing, the output signal can be allocated to any single or multiple output channels

Routing page multi track recording card subpage

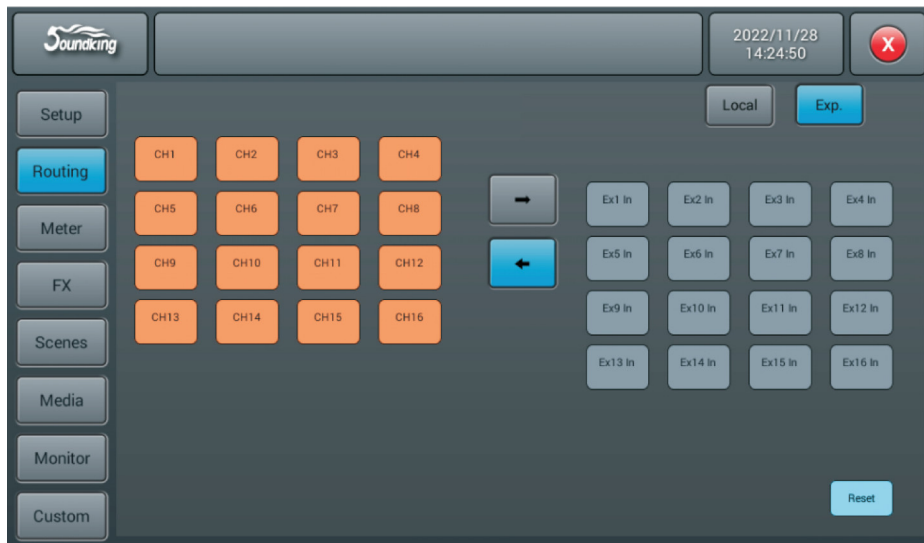

After the expansion is inserted, the input signal can be allocated to any single or multiple input channels of the expansion card
Reset key, restore the default value



After the expansion is inserted, the output signal can be allocated to any single or multiple output channels of the expansion card

Meter Page

The page contains two parts: signal level from input processing channel and outputs.

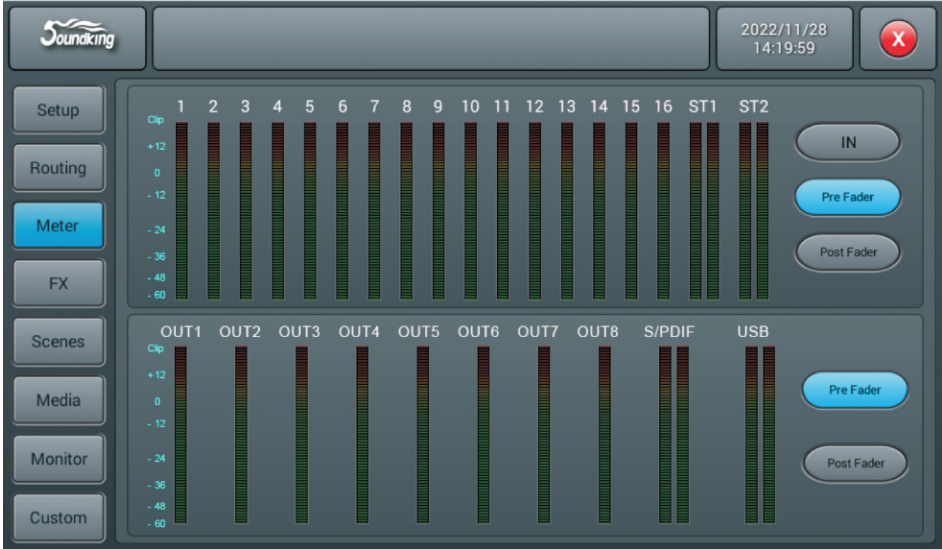

Signal level of input processing channel has three modes IN, Pre Fader and Post Fader with Pre Fader as the default. To select signal level mode to be displayed through single pressing the button. The signal level of output has two modes Pre Fader and Post Fader with Pre Fader as the default. To select signal level mode to be displayed through single pressing the button. On the right side of signal level of outputs you can see the bus names which are assigned to the port.

FX page



The Effects have 8 modules, which are 2 Modulation, 2 Delay, 2 Reverb and 2 15-band GEQ. All the modules can be inserted to input processing channel or bus processing channel, for one time only. Note, input processing channel can only be inserted with one effect module, while the bus can have two.

① **Effect module**

Double press the effect module, then a subpage of parameter setting of this module pops up. Single press the close button on the subpage to exit, and return to FX page.

② **Bus selection**

Single press the dropdown button , and select bus (Bus1~Bus8 Master LR) from a dropdown list. If the chosen bus has selected a FX module in the input part of the channel, then the left frame displays Selected FX modules in order of selection from left to right. If nothing has been chosen, you could drag the FX module above to the empty frame (if the FX module was occupied by other channel or bus, a dialog pops up "The module can be used only once and it is already used by **". Are you sure you want to use the module forcibly now "Yes or No").

Modulation Subpage

Double press "Modulation1 or 2" button in the FX Subpage, access to Modulation parameter tuning Subpage as below showed in the picture



① **Module Selection**

Single press left right selection button, to choose FX module (Modul1-Modul2-Delay1-Delay2-Reverb1-Reverb2-GEQ1-GEQ2)

② **Type**

Single press dropdown button, then choose a wanted type from the dropdown list Chorus Slow/Chorus Fast/Flanger Slow/Flanger Fast/Celeste Slow/Celeste Fast/Rotor Slow/Rotor Fast.

③ **Dry-Wet**

Ranges from 0 to 100 with a default @ 0. Adjust the parameter of Dry-Wet by dragging the slider, or turning the main Encoder on the control panel.

④ **EQ LS**

Curve chart: displays the LS curve

Gain: ranges is ±18 dB, with a default @ 0 dB. Adjust the Gain by turning the main Encoder or on the touch screen (fine tuning can be activated by pressing the main Encoder knob). Double press the parameter frame to set it as default.

Freq ranges from 20 Hz to 200 Hz, with a default @ 100 Hz. Adjust the Frequency by turning the main Encoder or on the touch screen (fine tuning can be activated by pressing the main Encoder knob). Double press the parameter frame to set it as default.

⑤ **EQ HS**

Curve: displays the HS curve

Gain ranges is ± 18 dB, with a default @ 0 dB. Adjust the Gain by turning the main Encoder or on the touch screen (fine tuning can be activated by pressing the main Encoder knob). Double press the parameter frame to set it as default.

Freq ranges from 1.5 KHz to 15 KHz, with a default @ 6.3 KHz. Adjust the Frequency by turning the main Encoder or on the touch screen (fine tuning can be activated by pressing the main Encoder knob). Double press the parameter frame to set it as default.

⑥ **Other parameters**

Speed ranges from 50 to 200, with a default @ 100. Adjust the Speed by dragging the slider, or turning the main Encoder on the control panel (fine tuning can be activated by pressing the main Encoder knob).

Intensity ranges from 50 to 200, with a default @ 100. Adjust the Intensity by turning the main Encoder or on the touch screen (fine tuning can be activated by pressing the main Encoder knob).

Pre Delay configure time of Pre Delay, ranges from 0~100ms, with a default @ 0ms. Adjust the time parameter by turning the main Encoder or on the touch screen.

Delay subpage

Double click on the "Delay1 or 2" button on the FX subpage to enter the Delay parameter adjustment subpage, as shown in the following figure.



① **Module Selection**

Single press left right selection button, to choose FX module: Modul1-Modul2-Delay1-Delay2-Reverb 1-Reverb2-GEQ1-GEQ2).

② **Type**

Single press dropdown button, then choose a wanted type from the dropdown list One Echo 1/4 Two Echo 1/8 Three Echo 1/16 Three Echo 1/16 Delayed Four Echo 1/16 One Echo 1/4 with 4 Reflect.

③ **Dry-Wet**

Ranges from 0 to 100 with a default @ 0. Adjust the parameter of Dry-Wet by dragging the slider, or turning the main Encoder on the control panel.

④ **EQ LS**

Curve chart: displays the LS curve

Gain ranges is ± 18 dB, with a default @ 0 dB. Adjust the Gain by turning the main Encoder or on the touch screen (fine tuning can be activated by pressing the main Encoder knob). Double press the parameter frame to set it as default.

Freq ranges from 20 Hz to 200 Hz, with a default @ 100 Hz. Adjust the Frequency by turning the main Encoder or on the touch screen (fine tuning can be activated by pressing the main Encoder knob). Double press the parameter frame to set it as default.

⑤ **EQ HS**

Curve chart: displays the HS curve

Gain ranges is ± 18 dB, with a default @ 0 dB. Adjust the Gain by turning the main Encoder or on the touch screen (fine tuning can be activated by pressing the main Encoder knob). Double press the parameter frame to set it as default.

Freq ranges from 1.5 KHz to 15 KHz, with a default @ 6.3 KHz. Adjust the Frequency by turning the main Encoder or on the touch screen (fine tuning can be activated by pressing the main Encoder knob). Double press the parameter frame to set it as default.

⑥ **Other parameters**

Factor ranges from 1/32 to 6, with a default @ 1. Adjust the Factor by dragging the slider, or turning the main Encoder on the control panel. (fine tuning can be activated by pressing the main Encoder knob).

Tempo ranges from 40 to 240 BPM, with a default @ 80. Adjust the Tempo by turning the main Encoder (fine tuning can be activated by pressing the main Encoder knob).

Tap Tempo: Keep pressing this button to set BPM value, at least three times of pressing.

Delay Time: ranges from 7.8 to 2000 ms, with a default @ 750ms. Adjust the time parameter by turning the main Encoder or on the touch screen (fine tuning can be activated by pressing the main Encoder knob). Double press the parameter frame to set it as default.

Delay Time can be configured by Factor and Tempo (see Chart 1 for the relation). Factor corresponds to regular tuning, while Tempo corresponds to fine tuning. For example, set Factor to 8, Tempo to 120 BPM, Delay Time is $500 \text{ ms} \cdot 60 \cdot 1000 / 120 = 500$. if set Factor to 9, Delay Time will be 1000 ms. if Factor to 7, Delay Time will be 250 ms.

⑦ **Lib**

Save and load user-defined Reverb Effects Library.

Chart 1

Factor	Ratio to BPM
1	1/32
2	1/24
3	1/16
4	1/12
5	1/8
6	1/6
7	1/4
8	1/2
9	1
10	2
11	3
12	4
13	5
14	6

Feedback: to return output delay into input, so as to generate echo from amplitude attenuation. Ranges from 0 to 90, with a default @ 0. To adjust by turning the main Encoder or dragging slider on the touch screen (fine tuning can be activated by pressing the main Encoder knob).

ReverbSubpage

Double press “Reverb1 or 2” in the FX Subpage, access to Subpage of Reverb parameter tuning, as showed in the picture below.



① **Module Selection**

Single press left right selection button, to choose FX module: Modul1-Modul2-Delay1-Delay2-Reverb 1-Reverb2-GEQ1-GEQ2).

② **Type**

Single press dropdown button, then choose a wanted type from the dropdown list Hall Bright/Hall Warm/ Room Bright/ Room Warm /Plate Bright/ Plate Warm.

③ **Dry-Wet**

Ranges from 0 to 100 with a default @ 0. Adjust the parameter of Dry-Wet by dragging the slider, or turning the main Encoder on the control panel.

④ **EQ LS**

Curve chart: displays the LS curve

Gain: ranges is ±18 dB, with a default @ 0 dB. Adjust the Gain by turning the main Encoder or on the touch screen (fine tuning can be activated by pressing the main Encoder knob). Double press the parameter frame to set it as default.

Freq: ranges from 20 Hz to 200 Hz, with a default @ 100 Hz. Adjust the Frequency by turning the main Encoder or on the touch screen (fine tuning can be activated by pressing the main Encoder knob).

Double press the parameter frame to set it as default.

⑤ **EQ HS**

Curve chart: displays the HS curve

Gain: ranges is ±18 dB, with a default @ 0 dB. Adjust the Gain by turning the main Encoder or on the touch screen (fine tuning can be activated by pressing the main Encoder knob). Double press the parameter frame to set it as default.

Freq: ranges from 1.5 KHz to 15 KHz, with a default @ 6.3 KHz. Adjust the Frequency by turning the main Encoder or on the touch screen (fine tuning can be activated by pressing the main Encoder knob).

Double press the parameter frame to set it as default.

⑥ **Other parameter**

Time: the parameter can set the basic size of simulated room, ranges from 0 to 15 s, with a default@8 s.

To adjust by turning the main Encoder or on the touch screen (fine tuning can be activated by pressing the main Encoder knob). Double press the parameter frame to set it as default. Chart 2 is time parameter range and default setting of different types.

Chart 2 is time parameter range and default setting of different types.

⑦ **Lib**

Save and load user-defined Reverb Effects Library.

Chart 2

Type	Min	Max	Default
Hall Bright	0.8 s	12.0 s	1.6 s
Hall Warm			
Room Bright	0.4 s	8.0 s	0.8 s
Room Warm			
Plate Bright	0.4 s	6.0 s	0.6 s
Plate Warm			

Pre Delay: configure time of Pre Delay, ranges from 0~100ms, with a default @ 0ms. To adjust by turning the main Encoder or on the touch screen (fine tuning can be activated by pressing the main Encoder knob). Double press the parameter frame to set it as default.

GEQ Subpage

Double press "GEQ 1 or 2" in the FX Subpage, access to Subpage of GEQ parameter tuning, as showed in the picture below.



① Module Selection

Single press left right selection button, to choose FX module: Modul1-Modul2-Delay1-Delay2-Reverb 1-Reverb2-GEQ1-GEQ2.

② Library

Save or load user's EQ settings. Single press the dropdown button and select a library file from a popped-up list, in order to load the EQ setting. Single press the " Save " button after you have done with EQ settings, then select the library file (there are 16 names of library, Preset 1~Preset16) which can be edited through the soft-keyboard popping up. At last, press " confirm " or " cancel " to save file name or not.

③ GEQ Chart

The right side shows the Gain coordinate(+18 0 -18 dB), The up side shows the Frequency coordinate And gain value (default@0dB) of corresponding frequency point.Drag the slider up and down to adjust gain of frequency point, or use corresponding physical faders to do it.

④ Operation

Bypass: Single press the button, to enable Bypass. Press again to disable it. The default is disabled.

Flat: Single press the button, to set all gains of frequency points back to 0, bring slider in the middle (faders will be in the middle position of stroke if they are used to control), The default is disabled.

⑤ Fader selection button1-8

Single press the button, to control the gains of frequency points with 8 faders on the panel.

9-15 Single press the button, to control the gains of frequency points with 7 faders on the panel.

1-8 / 9-16 / 17-24 / 25-31: Single press 4 keys to switch between frequency points, use the 8 faders on the panel to adjust the gain of frequency point.

Scenes Page

The page contains Scene List and operations for scenes.

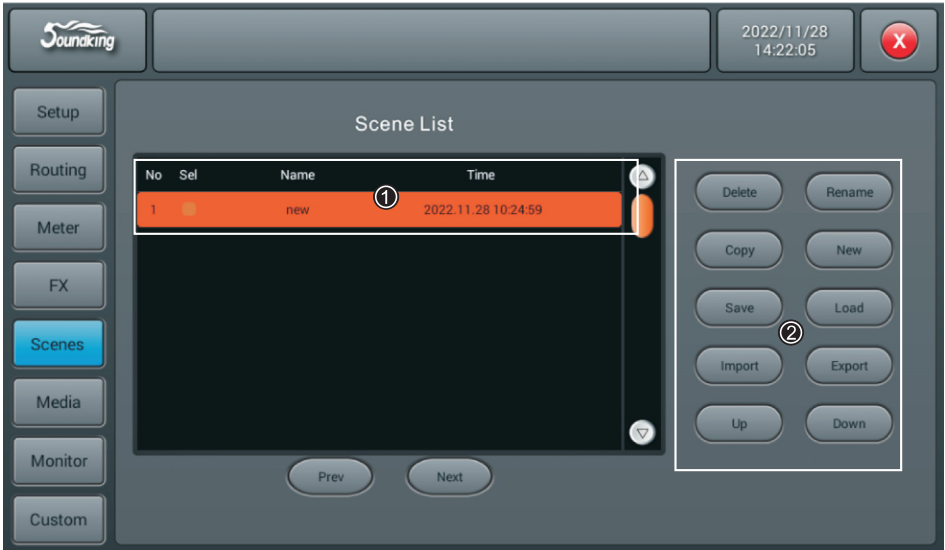

① Scene List

Scene List contains number(No) selection(Sel) name(Name) and creat/update time(Time). To select a certain scene through single pressing option frame in the Sel column.

② Operation

Delete Delete scenes. When select a scene, single press the button, a dialog pops up " Are you sure you want to delete this scene" single press " Yes " to delete the scene, single press " No " to cancel delete.

Rename Rename scene. When select a scene, single press the button, then you could edit the name of the scene through a soft-keyboard popping up. Press confirm once you have renamed the scene.

Copy Copy scene. When select a scene, single press the button, to insert copied new scene after selected scene, the system will automatically name it as " (copied scene name)_copy ".

New Create scene. Single press the button, to insert new scene after selected scene or current scene, system will name it as " New " (* being a number, equals to the number of scene+1).

Save Save scene. Single press the button, to save console's settings to the current scene.

Load: Load scene. When select a scene, single press the button to load the scene.

Import load a scene from a USB disk. Single press the button, a dialog pops up " Compressed file list ", select scene* list beneath " Compressed file list ", to load scene from USB disk to the scene list on the console. If load successfully, system prompts " Import success ", press " Confirm " and selected scene will be transported to the console from the U disk. If USB disk cannot be found, then prompts " No USB stick detected, please reconnect and try again." If cannot find scene file in the USB disk, then prompts " Scenes file not found on USB stick! ". If loaded scene shares a same name with the scene file in the console, the system will automatically rename it as " (original file name)_USB ".

Export Export scene file from console to USB disk. Single press " Sel " option frame in the scene list, to select scene to be exported. They can be exported individually or multiply. Then single press " Export " button. If export successfully, system prompts " Export success ", press " Confirm " to export selected scenes to USB disk. If USB disk cannot be found, then prompts " No USB stick detected, please reconnect and try again."

Up move scene upward. When select a scene, single press the button to move selected scene upward, one press for one row.

Down move scene downward. When select a scene, single press the button to move selected scene downward, one press for one row. This function can be used to serve sorting purpose in both ascending order and descending order.

Prev browse previous scene. Single press " Load " to load the current scene once you have seen the scene you want

Next browse next scene. Single press " Load " to load the current scene once you have seen the scene you want

Media Page



① Player

The player can display the name of selected soundtracks and playback progress, includes 8 function buttons: stop (■) play/pause (▶/⏸) previous (◀) rewind (◀◀) forward (▶▶) next (▶) play mode (🔄) and record (●).

② Meter display of playback and record

Display meter of Playback and Record in real time.

③ Playback list

Display playlist in the USB disk, single press a soundtrack to play it.

④ Record

Record switch is OFF as default, and the sound source to be recorded is from Master L/R, single press the record button to record audio content of Master L/R bus to the USB disk in .WAV format.

Monitor Page

The page mainly contains settings for Oscillator, Monitor / Phones and Solo.



① Oscillator

Oscillator of the console used for system test and calibration.

On/Off Switch: Single press the button to switch on (ON) Oscillator, press again to switch off. The default is disabled.

Type: there are three types of signals generated by Oscillator White noise/ Sine wave/ Pink noise, Single press an option in the list to select a Oscillator type.

Level: ranges from -8 dB to 0 dB, with a default @ 30 dB. Adjust the Level by turning the main Encoder or on the touch screen (fine tuning can be activated by pressing the main Encoder knob). Double press the parameter frame to set it as default.

Frequency: Frequency settings for "Sine wave", ranges from 10 Hz to 20 kHz, with a default @ 1 KHz. Adjust the parameter value by turning the main Encoder or on the touch screen (fine tuning can be activated by pressing the main Encoder knob). Double press the parameter frame to set it as default.

Destination: double press the bus in the list to enable the bus to which Oscillator signal transmits

② Monitor/Phones

On the upper right there is a Phone jack connector, and an analogue potentiometer knob for controlling the volume of earphone. A pair of three-core jack output connector for stereo monitor on the back panel, is used to connect monitor speakers.

Level: ranges from -8 dB to 0 dB, with a default @ -20 dB. Adjust the Level value by turning the main Encoder or on the touch screen (fine tuning can be activated by pressing the main Encoder knob). Double press the parameter frame to set it as default.

Mute: Single press the button to lighten the red LED button and mute monitor signal, press again to disable mute. The default is disabled. Note: The phone signal and monitor signal are the same, which is subject to control of monitor level and mute, except analogue gain.

Meter Display: Display Monitor level of output signal in real time.

③ Solo

If none of SOLO buttons is pressed down on the panel, therefore monitor is fed with master output. When press down any of SOLO button, then the channel feeds monitor with AFL or PFL signals. Press once to enable SOLO, press again to disable it.

PFL monitors pre-fader signal which is not subject to control of faders and mutes. If PFL is chosen for stereo channels, then it feeds monitor with a mixed signal from left and right channels. AFL signal monitors post-fader signal which is subject to control of faders and mutes.

AFL/PFL Select button: Choose a mode of monitor, while default is AFL mode. Single press the button and switch to PFL mode, press again to resume AFL mode.

Trim: Gain tuning of AFL or PFL, ranges from -8 dB to 0 dB, with a default @ -20 dB. Adjust the Trim by turning the main Encoder or on the touch screen (fine tuning can be activated by pressing the main value Encoder knob). Double press the parameter frame to set it as default.

Meter Display: Display the level of Solo signal in real time.

Custom Subpage

Custom Shortcuts Subpage



The shortcut keys on the panel can be edited freely in this interface

Custom Layer Settings



In this interface, you can edit any channel of the self defined layer

As shown in the following figure, (input, output and DCA are displayed in one page)



Set Mute Group



Select the MG1 option to enter the group configuration page. The mute group configuration is empty by default, and the settings can be changed as required.

Dimension Drawing

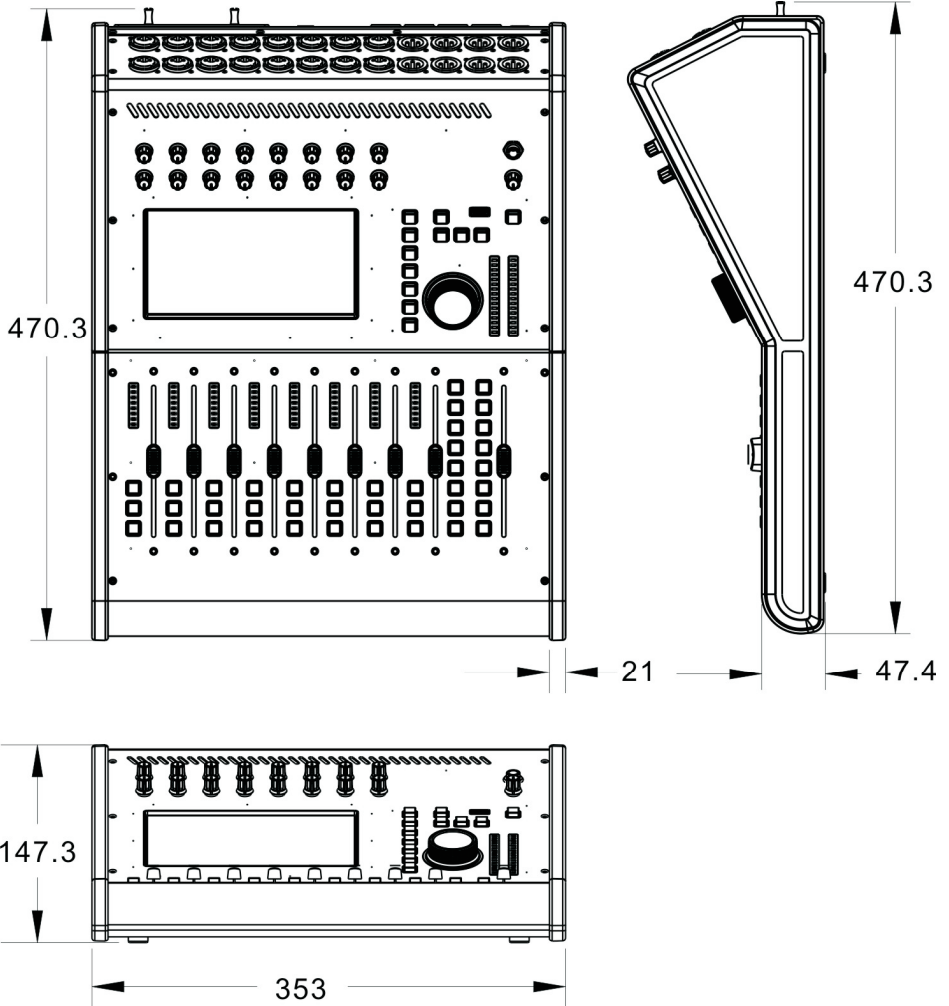

Signal Flow Diagram

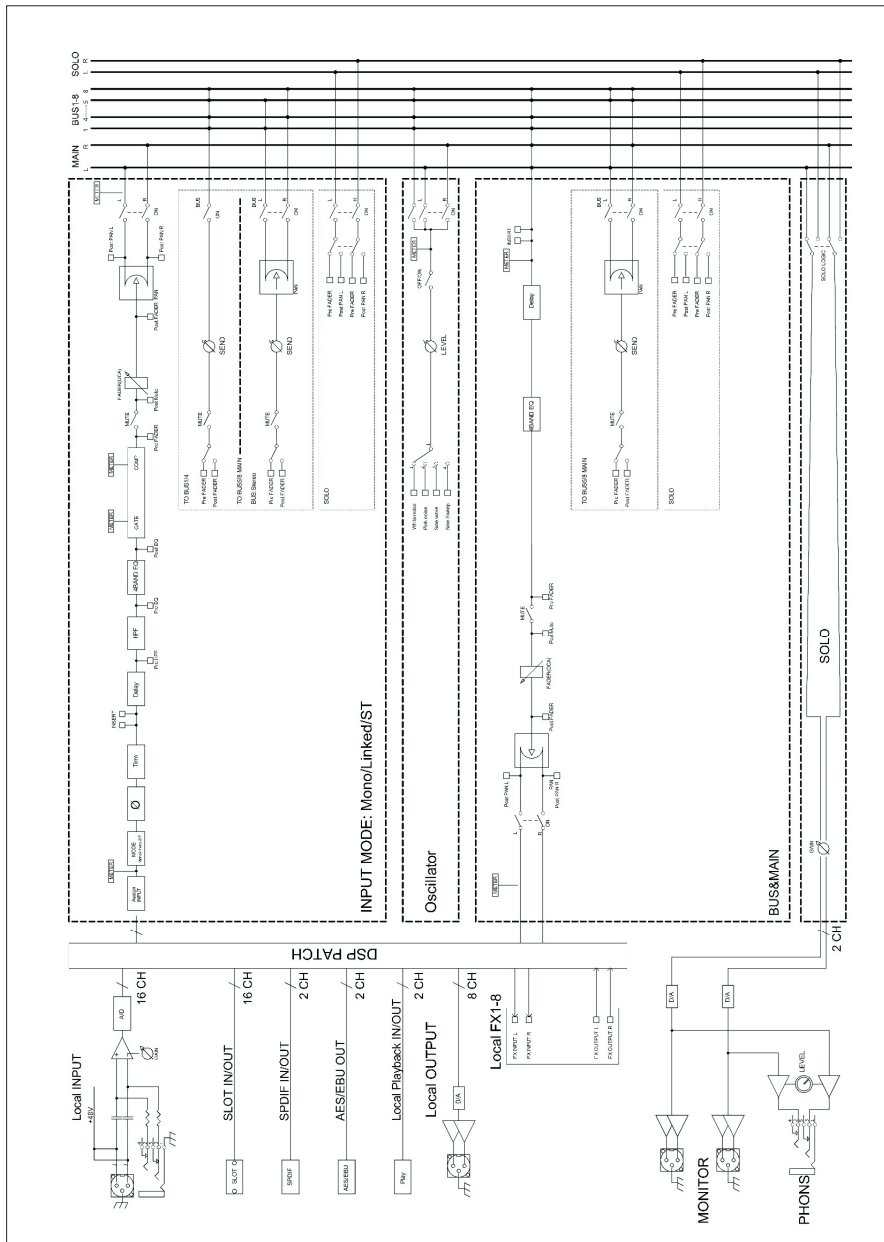

Specification

Input channel	20
Bus	8
Stereo bus	1
Effect	2 modulation, 2 delay, 2 reverb, 2 GEQ
DCA group	6
Mute group	2
Self-defined key	Support
Self-defined layer	Support
Sampling rate	24bit/48kHz
Local mic input	12 x XLR+4xCOMBO
Local digital input	1 x S/PDIF
Local output	8 x XLR
Local digital output	1xAES/EBU
Monitor output	2x XLR
Earphone output	1x1/4" TRS
Mic amplifier	16ch Class A analog amplifier
Fader	8x110mm channel,1x110mm main channel
Screen	7" 1024x600
RS485 port	Support
Power supply	AC 100-240V 50/60Hz
Dimension	470. 3*353*147. 3mm
Net weight	6. 5kg

SOUNDKING AUDIO
WWW.SOUNDKING.COM

All rights reserved to SOUNDKING.

No part of this manual may be reproduced, translated or photocopied
by any means for any purpose, without the written permission of SOUNDKING.

The information involved in this manual is subject to change without notice.
Never disassemble the unit by yourself, it may cause the invalidation of warranty.

