

## TRADEMARK AND LICENSES



**SOUNDVISION™** is a trademark of SOUND VISION CO., LTD. registered in the Thailand,China,Laos and other countries. Names are trademarks or registered trademarks of their respective owners.

# SOUNDVISION™

## SU-990D PLUS SERIES

DIGITAL UHF  
*True diversity*

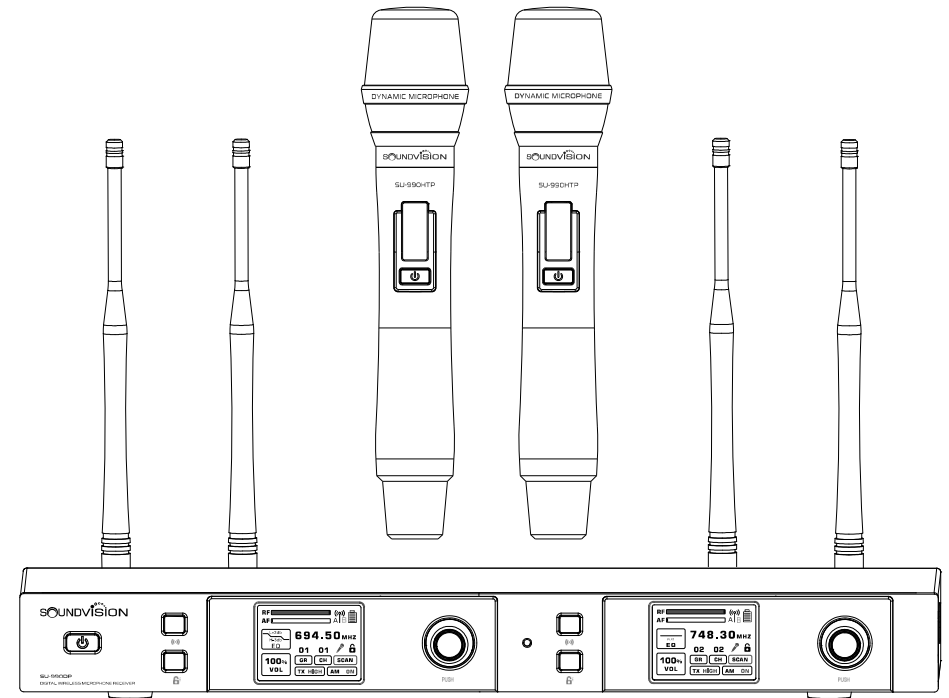

## SOUND VISION CO., LTD.

9 Chaiyaphruek Rd.,Taling Chan,Taling Chan,  
Bangkok 10170 Thailand

Support : 02-433-9988 LINE Official : @soundvisionpro

Email : info@soundvision.co.th www.soundvisionpro.com



## DIGITAL WIRELESS MICROPHONE SYSTEMS

# USER MANUAL

---

## CONTENTS

<b>INTRODUCTION</b>	<b>2</b>
<b>FEATURES</b>	<b>2</b>
<b>RECEIVER</b>	<b>3</b>
<b>CONTROL KNOB</b>	<b>4</b>
<b>RECEIVER TFT FUNCTIONS SETTING</b>	<b>5</b>
<b>HANDHELD MIC OPERATION</b>	<b>6</b>
<b>TRANSMITTER OPERATION</b>	<b>7</b>
<b>RECEIVER OPERATION</b>	<b>8</b>
<b>SPECIFICATION</b>	<b>9</b>
<b>WARNING</b>	<b>10</b>

### CAUTION!

Please do read this manual carefully before using. Wireless microphones can scatter radio energy, please do follow the instruction to install and operate in case causing harmful influence. Do abide local radio regulations when using wireless microphones. We can offer you frequency products, and please choose specific range according with local radio regulations; otherwise, you will take full responsibility of all consequences.



## WARNING

- Do place receiver in open space, so that it can receive signals better.
- Do not throw the device.
- Do not place the device under rain or drop it into water.
- Keep device away from sunshine or electromagnetic field.
- Do insert batteries in the right way and remove them if device is idle for long time.
- Cut off power the supply before battery replacement.
- Pull out power adaptor from the power supply if the receiver is idle for long time.
- Do not take apart device without permission in case users are injured.
- Device does not contain any part for self-refuting, otherwise, the warranty will be void.
- Use soft cloth to clean device, if there is any stubborn stain, clean it with neutral detergent but not volatile gasoline or thinner.
- Keep at least 30CM space around device for better ventilating.
- Do not cover ventilation holes with paper, tablecloth or curtain.
- Do not put the fire on device like burning candle.
- Keep device away from water drops, or any container with liquid like vase.
- Do not use new and old batteries at the same time, besides, replace them with same kind batteries. Discarding batteries to specific recycling bin.
- Working temperature: 5°C - 60°C

Please try below methods to solve interfered problem when using wireless microphones

- Adjust place or direction of the antenna.
- Keep away from radio or TV.
- Do not plug into same electrical socket outlet with radio or TV.
- The best angle is 45° for mouth and microphone when speech, in order to reduce affected by airflow from the mouth.
- Using 1 microphone when 1 sound input, otherwise sound will be mixed.
- Keep a distance of mouth and microphone less than 15CM because of cardioid pickup, otherwise bass is not good.

## SPECIFICATIONS

### SYSTEM

Carrier Frequency	UHF 694.5 ~ 702.7 , 748.3 ~ 757.7MHz
Available Channels	180CH CH-A : 20Group (85CH) , CH-B : 20Group (95CH)
Bandwidth	17.8MHz
Dynamic Range	96dB
Total Harmonic Distortion	<0.1%
Frequency Response	30Hz ~ 20kHz ±2dB
Demodulation Mode	DQPSK
Sampling Rate	48 KHz
Audio Output Level	1 x 6.3mm, 2 x XLR balance output

### SU-990DPR : RECEIVER

Frequency Response	30Hz ~ 20kHz ±2dB
Power Supply	DC 12V-18V 1A
Consumption Power	4 Watts
Signal/Noise Ratio	96dB
Receiving Sensitivity	-95dBm

### TRANSMITTER

Carrier Frequency	UHF 694.5 ~702.7 , 748.3 ~757.7MHz
- Frequency range Group A	694.5 ~ 702.7 MHz ;
- Frequency range Group B	748.3 ~ 757.7 MHz
Available Channels	180CH
- Channels A : 20Group	85CH
- Channels B : 20Group	95CH
Bandwidth	17.8 MHz
Frequency Switch	IR SYNC

### SU-990HTP : HANDHELD TRANSMITTER

Microphone Type	Dynamic
Polar Pattern	Cardioid Directional
Frequency Response	50Hz - 18kHz ±3dB
Impedance	600Ω ±30% @1kHz
Sensitivity	-60dB ±3dB (0dB=1V/Pa @1kHz)
Output Power	10mW/30mW
Harmonic Radiation	<-50dBc
Battery Voltage	3V (2 x 1.5V AA Battery)
Battery Life (Alkaline Type)	approx 8 hours

### SU-990BTP : BODYPACK TRANSMITTER

Output Power	10mW/30mW
Harmonic Radiation	<-50dBc
Battery Voltage	3V (2 x 1.5V AA Battery)
Battery Life (Alkaline Type)	approx 8 hours

### LAVALIER (LV-X) | HEADWORN (HW-X)

Microphone Type	Condenser
Frequency Response	20Hz - 20kHz
Impedance	32Ω ±15%
Sensitivity	-38 ±2dB @1kHz; 1mW
Distortion	1% @ 1KHz
Connect	Mini XLR 4-Pin

## INTRODUCTION

Our company has designed and developed this excellent wireless microphone system using a fully integrated solution, microphone system is very easy to install and convenient to use. This model SU-990D adopts intelligent cryptographic hardware, to achieve unique sound and rf performance frequencies group, TFT display menu on receiver shows and battery make it easy installation.

## FEATURES

- Digital UHF 694.5 ~ 702.7 , 748.3 ~ 757.7 MHz frequency range.
- Frequency response 30Hz ~ 20kHz ±2dB
- Pre-Set 180CH selectable frequencies (CH-A : 20Group (85Channels), CH-B : 20Group (95Channels)).
- True diversity system with 4 antennas.
- Unique digital 16 bits ID pilot technology, no crosstalk disturbance even same frequency.
- IR sync downloading the frequency from the receiver.
- Wireless system adopts Intelligentized cryptographic hardware.
- TFT display to indicate frequency AF / RF signal, battery level, Group, Channel and Menu Settings.
- Auto frequency scanning and spectrum display.
- Equalizer 9 Presets : 0, ±3db (Flat / low shelf cut / high shelf cut / high shelf boost / low shelf boost)
- Up to 120 Meters line-of-sight range.
- Auto mute when falling or laid down.
- An efficient battery energy design that allows the microphone to be used continuously for longer periods of time.
- Ideal for large and small stages, clubs music entertainment, conference, meeting, training, speeches and karaoke etc.

### SU-990HTP wireless handheld transmitter

- Generation of new elegant design
- Interchangeable microphone capsules
- Microphone compatible with other brands of mic (Shure Beta®58A, SM58® or etc.)

### SU-990BTP wireless bodypack transmitter

- Professional audio quality wireless performance.
- Easy to use quickly syncs with a wireless receiver.
- OLED with easy-to-navigate menu and controls.
- Housing Cast aluminum.

Certifications : CE and RoHS / The SU-990D Series conforms to standard  
NBTC | ETSI EN 300 422-1, IEC 62368-1:2018

RECEIVER

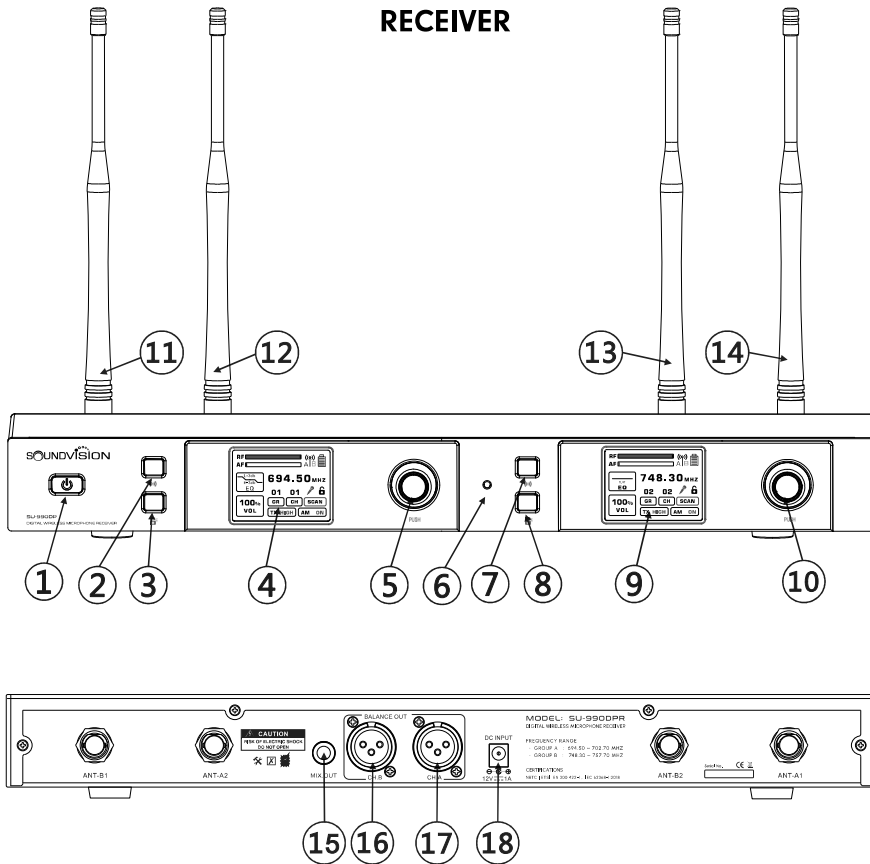

- |                                   |                                    |
|-----------------------------------|------------------------------------|
| 1. POWER                          | 10. VOLUME/FUNCTION / CONFIRM-B CH |
| 2. IR-A CH                        | 11. ANTENNA - A1 CH                |
| 3. UNLOCK-A CH                    | 12. ANTENNA - B1 CH                |
| 4. TFT DISPLAY-A CH               | 13. ANTENNA - A2 CH                |
| 5. VOLUME/FUNCTION / CONFIRM-A CH | 14. ANTENNA - B2 CH                |
| 6. IR INDICATOR                   | 15. MIX. OUT                       |
| 7. IR-B CH                        | 16. BALANCE OUT-B CH               |
| 8. UNLOCK-B CH                    | 17. BALANCE OUT-A CH               |
| 9. TFT DISPLAY-B CH               | 18. DC INPUT                       |

RECEIVER OPERATION

- Power Connection:  
Connect the attached adaptor to DC input port (18).
- Audio Output Connection:  
Mix Output: connect one end of the attached audio cable into OUT.  
Mix port (15), meanwhile connect the other end to MIX IN or AUX IN port of mixer or speaker.

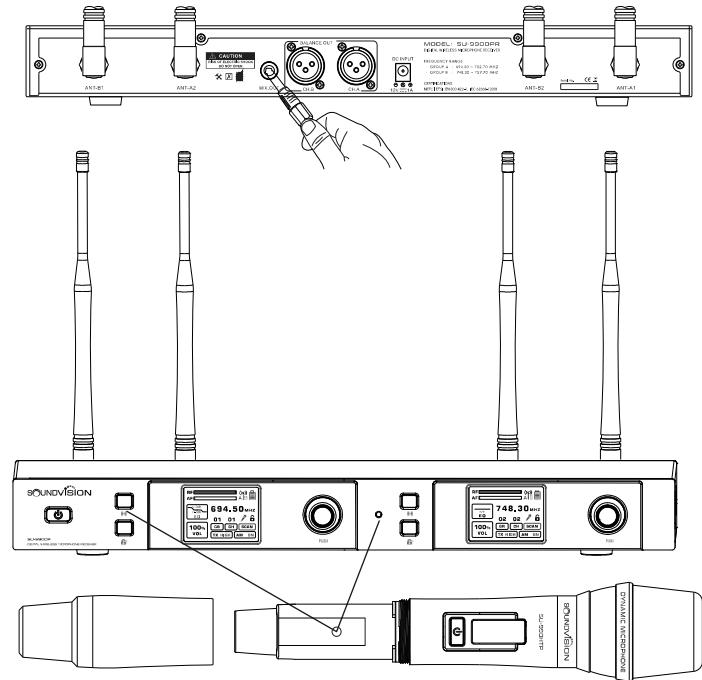

SNYC IR operation shows as above picture. Boot up receiver, firstly long press UNLOCK button to unlock system, and then choose non-interference frequency, and then long press IR button for 3 seconds till the IR indicator flashing and transmit IR signal, meanwhile, boot up microphone and keep its IR window close to receiver's. Same frequency will show on microphone and receiver at the same time when IR SNYC successfully, and RF signal will show on OLED on receiver.

### HANDHELD MICROPHONE USING TECHNIQUE

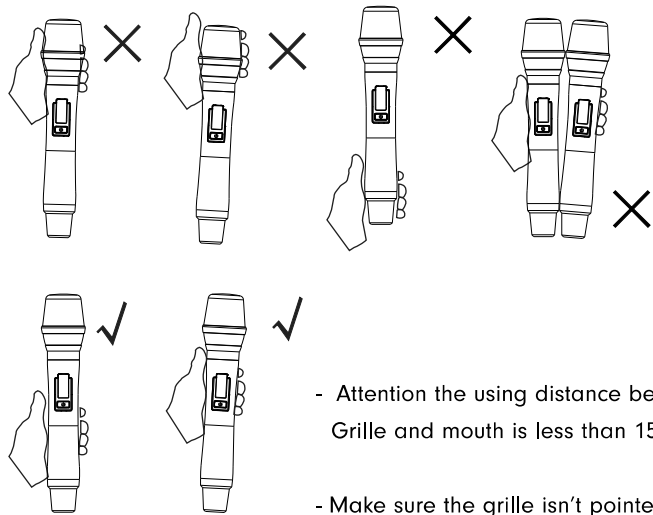

- Attention the using distance between the microphone Grille and mouth is less than 15cm.
- Make sure the grille isn't pointed at the horn.

### BODY-PACK TRANSMITTER (OPTIONAL)

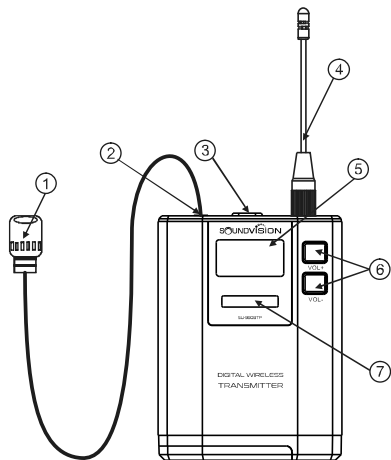

1. Microphone: pick up sound.
2. Input Socket.
3. ON OFF: power switch.
4. Antenna.
5. OLED: indicates bodypack working status.
6. - VOL + : volume control.
7. IR: SYNC IR signal with receiver IR window.

### CONTROL KNOB



In the state of , contra rotate SET knob to reduce volume, while clockwise rotate it to increase volume.



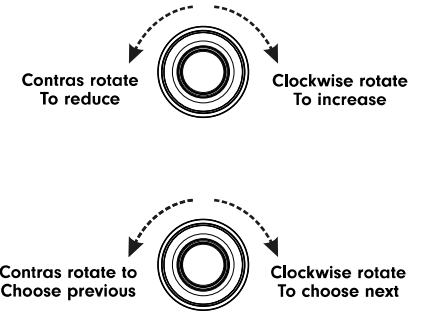



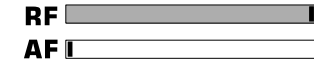
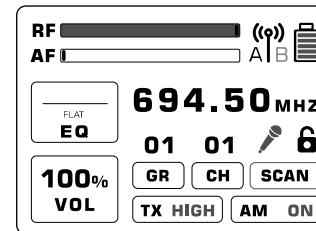

In the state of , SET knob is used for choosing, editing function and confirming, contra rotate it to choose previous item, while clockwise rotate it to choose next item.



### RECEIVER TFT DISPLAY

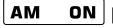

RF: Indicate signal strength, the longer length of the color, the stronger signal.  
 AF: Indicate audio level, the longer length of the color, the stronger signal.

-  Diversity signal symbol
-  MUTE symbol
-  Audio Effect Setting menu and condition
-  Power of working handheld microphone
-  Diversity signal symbol
-  Receiver volume
-  Frequency scanning menu
-  Microphone transmit setting menu
-  Microphone auto mute setting menu

**694.50MHz** Receiver working frequency is 694.50MHz  
**01 01** Group 01 Channel 01  
**GR CH**

### RECEIVER TFT FUNCTIONS SETTING

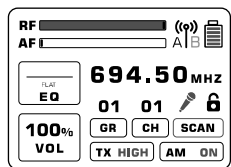

#### EQ OFF

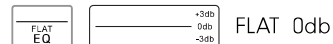

#### EQ ON

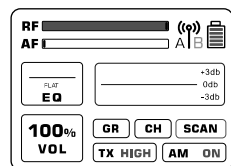
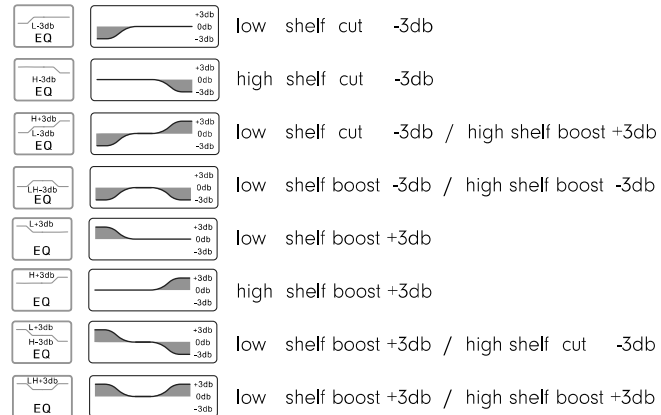

#### Frequency Setting

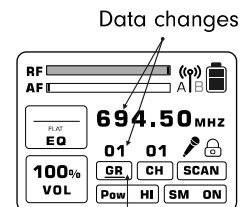

Frequency Group Menu

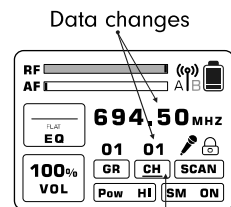

Frequency Channel Menu

#### Frequency Scan Setting

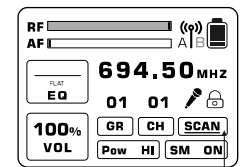

Frequency Scan Menu

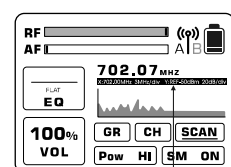

Data changes

### RECEIVER TFT FUNCTIONS SETTING

#### Transmitted Power and Auto Mute Setting

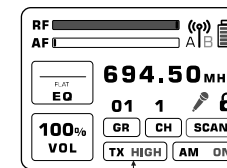

TX Power Menu

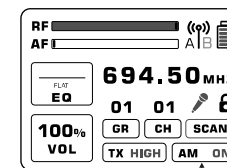

Auto Mute Menu

NOTE : Above 2 functions can work properly only if re-SYNC after setting.

### HANDHELD MIC OPERATION

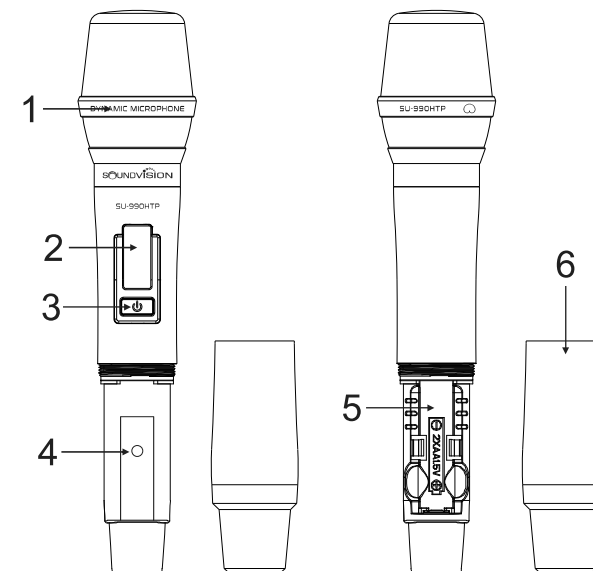

- 1. CARTRIDGE : pick up sound.
- 2. OLED DISPLAY : indicates microphone working status.
- 3. IR WINDOW : SYNC IR signal with receiver IR window.
- 4. POWER BUTTON : control handheld microphone to be power on, off and mute.
- 5. BATTERY SINK : insert 3V (2×1.5V AA Battery)
- 6. BATTERY COVER : unscrew it when change batteries.